

STC8H8K64U 开发系统板

TTL转232串口电路 串口3_2

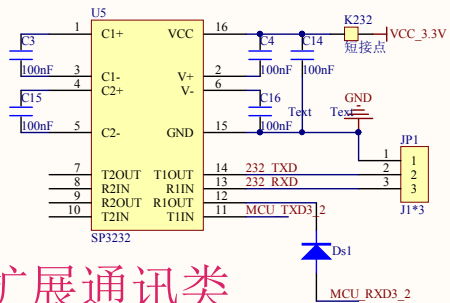

485电路 串口4_2

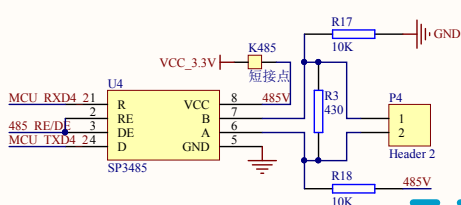

蜂鸣器电路

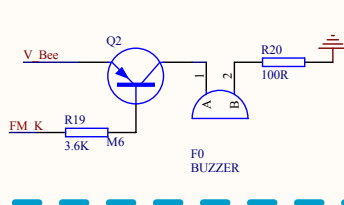

2.4G NRF接口

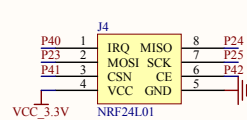

WIFI接口 esp8266

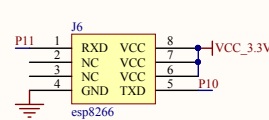

4.0蓝牙接口

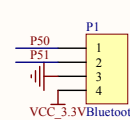

扩展模块接口

扩展通讯类

USB下载P32短路电阻

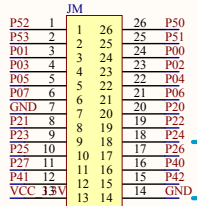
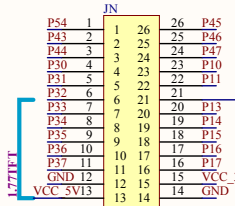

IO端口

TF Card模块

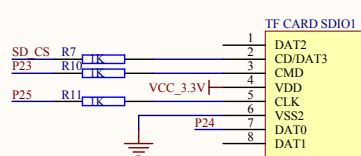

FLASH存储芯片

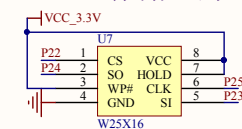

外部存储

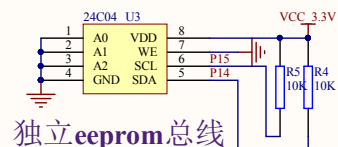

IO控制外设

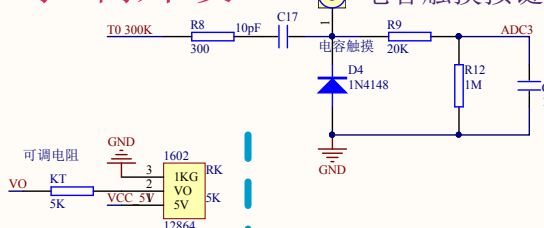

电容触摸按键

高精度ADC基准源

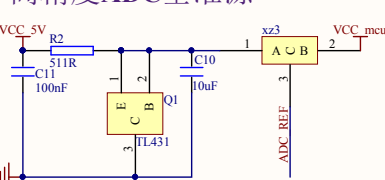

双USB连接

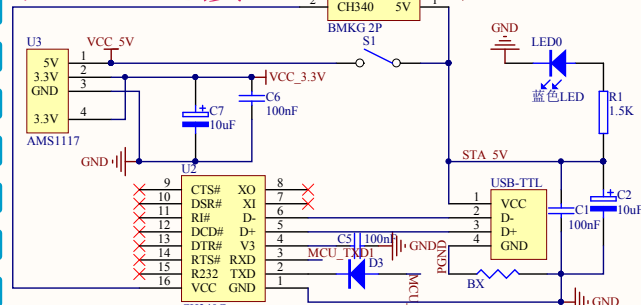

外电源接口

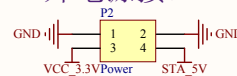

USB2.0端口

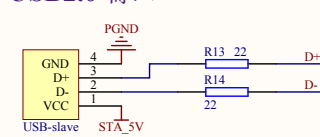

LCD电路部分

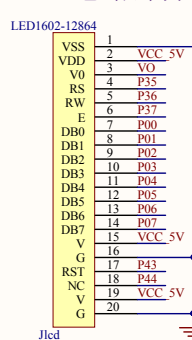

IO端硬件按键

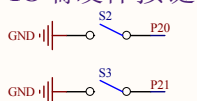

IO端控制LED

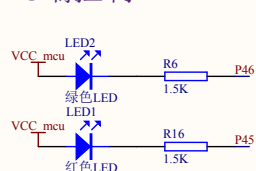

MCU供电电源选择

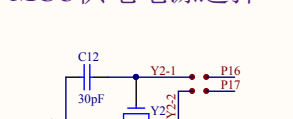

mcu外部硬挺晶振

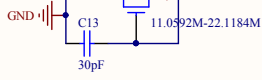

USB-TTL下载及PC与mcu串口通讯

MCU-STC8H

